

MEGA Temporary (340–400 mm)

USE ON MASONRY AND
CONCRETE

Classification/system components

Designation: Anchor system for ETICS, ventilated curtain wall façade and cavity wall for production of temporary anchoring according to DIN EN 12811-1:2004-03 (temporary constructions for buildings - Part 1: Work scaffold / German standard). Can be used on masonry and concrete.

Add. feature: for structure thicknesses from 340–400 mm

rocketplug: Plastic wall plug

rocketbase: Load distribution plate, galvanised steel, \varnothing 180 mm

rocketbody: Anchor body, plastic (glass-fibre reinforced)

rocketbolt: Eye-bolt, special steel, \varnothing 18 mm

rocketseal: Plug, plastic body with hex stainless steel insert

Art. number: 9.1.330

Accessories (available separately)

rocketglue: fast-hardening composite glue for initial adhesion of the load distribution plate

Assembly set: Available as Standard or Extended (for ETICS panels). Necessary special tools for assembly of the **isorocket®** permanent scaffold anchor



Product description:

The **isorocket®** scaffold anchor **MEGA Temporary** is a temporary anchor system according to DIN EN 12811-1:2004-03 (German standard) for external thermal insulation composite systems (ETICS), ventilated curtain wall façade (VCW) and cavity wall that protects the façade against damage right from the outset. **isorocket®** remains as a permanent, almost thermal bridge-free anchor point in the façade and can therefore be reused at any time after the anchor points have been checked. Thanks to its ideal force dissipation, the **isorocket®** scaffold anchor not only ensures a secure hold of the construction scaffold, it is also useful for various uses in new buildings and also later. The extensive work required to fix damage to new façades, for instance damage often caused by conventional ring screws, is now a thing of the past. The **isorocket®** scaffold anchor **MEGA Temporary** is suitable for structure thicknesses of 340–400 mm on masonry and on concrete. The permanent anchor system allows clean separation of the various trades and does not leave any mutual dependencies between the façade and scaffold construction.

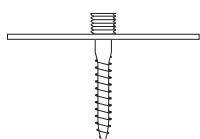

rocketbase (Load distribution plate)



rocketplug (Wall plug)

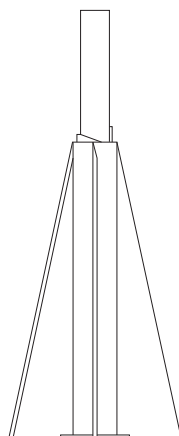

rocketbody (Anchor body)



rocketbolt (Eye-bolt)



rocketseal (Seal)

Anchor system for ETICS, VCW and Cavity wall for production of temporary anchoring (DIN EN 12811-1:2004-03 / German standard) for use on masonry and concrete. Remains permanently in the façade and can be reused at any time after the anchor points have been checked.

MEGA Temporary (340–400 mm)

USE ON MASONRY AND
CONCRETE

DIMENSIONS

rocketbody (Anchor body) / rocketbase (Load distribution plate)

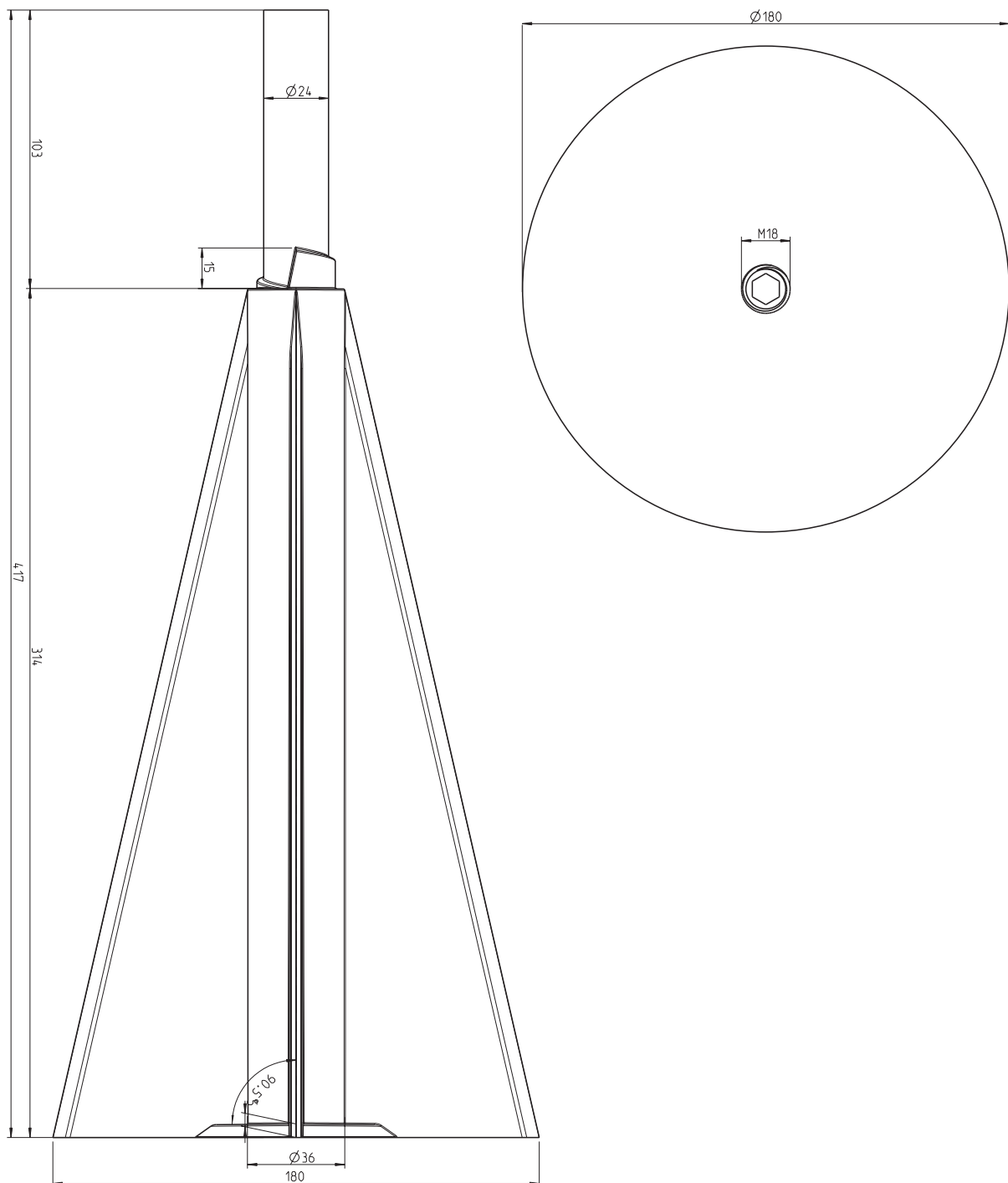

isorocket®

ANCHOR SYSTEM
FOR ETICS/VCW/
CAVITY WALL

MEGA

MEGA Temporary (340–400 mm)

USE ON MASONRY AND
CONCRETE

CAD SCREEN

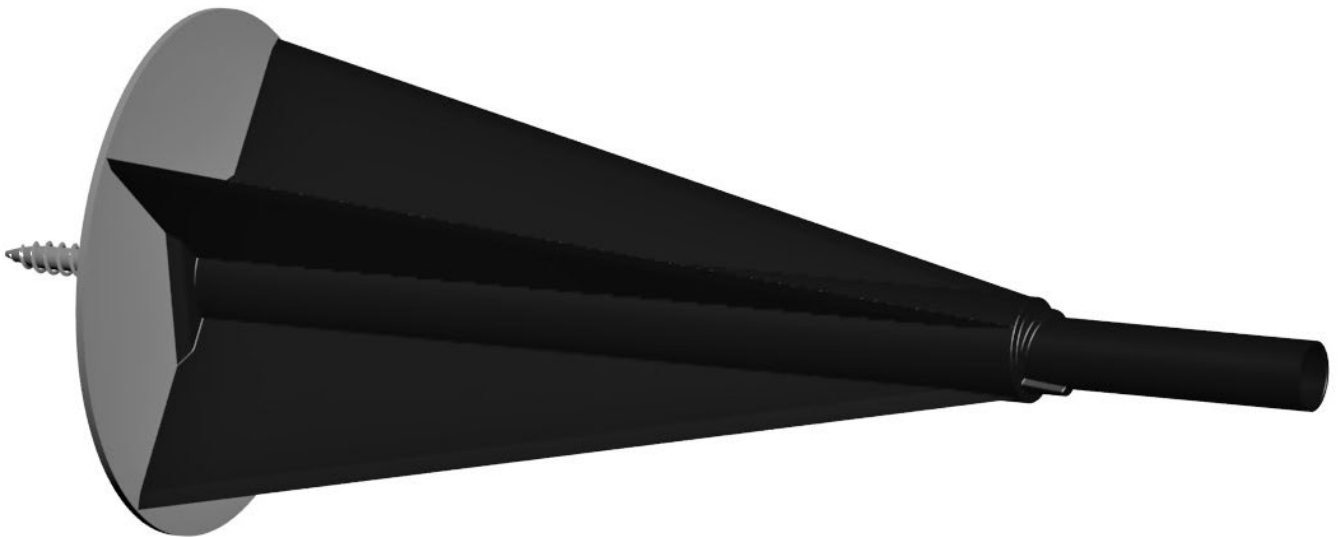

The CAD data for this permanent anchor system are available for download at www.isorocket.de

isorocket®
GERÜSTANKER